

SOLAR PANEL (HEAVY DUTY)

ALUMINIUM

www.kamcoaluminium.com | sales@kamcoaluminium.com



Innovator In Aluminium

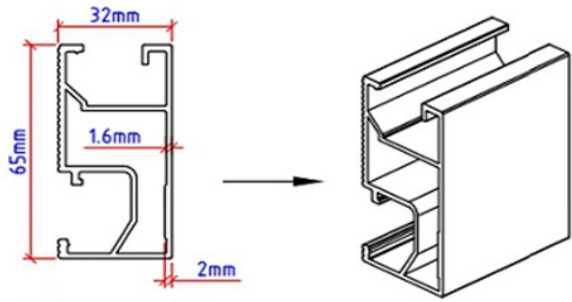

**MAIN FRAME
LK5275**
Scale 1:2
Length : 6.1 M
Finishing : N.A

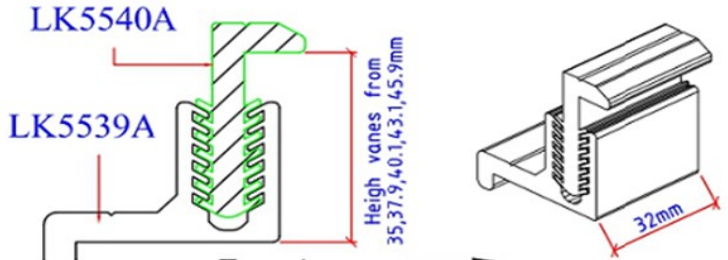

**Type 1
FLEXIBLE Z CLAMP
LK5539A & LK5540A**
Length : 32 mm
Finishing : M.F

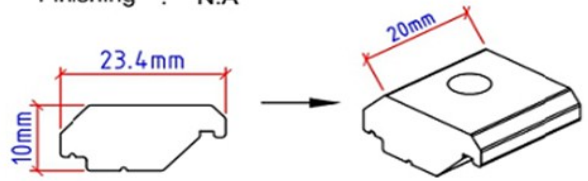

**SCREW NUT
LK5277**
Scale 1:1
Length : 20 mm
Finishing : M.F

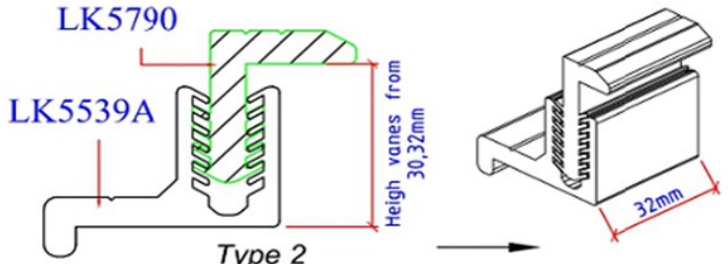

**Type 2
FLEXIBLE Z CLAMP
LK5539A & LK5790**
Length : 32 mm
Finishing : M.F

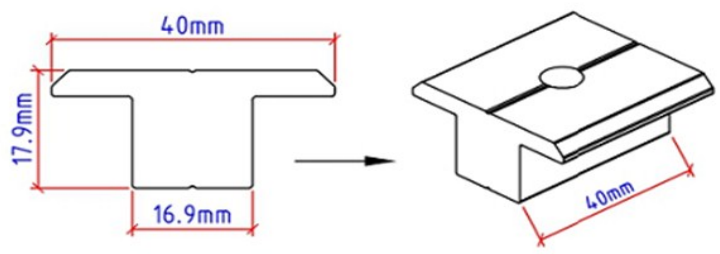

**CENTRE T BRACKET
LK5278**
Scale 1:1
Length : 40 mm
Finishing : M.F

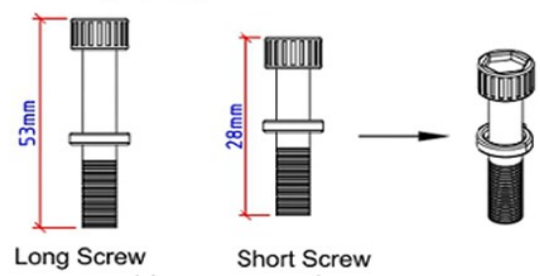

**Stainless Steel 304 M8 Short Screw
With Spring Washer**

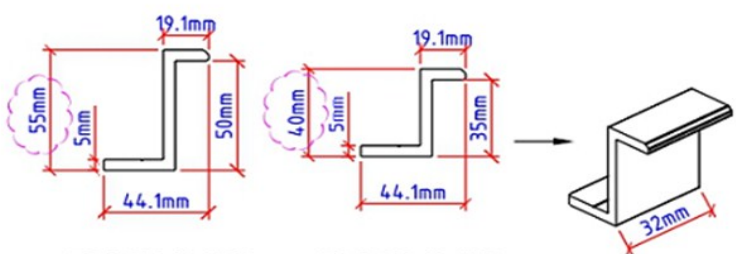

**EDGE Z CLAMP
LK5279**
Scale 1:3
Length : 32 mm
Finishing : M.F

**EDGE Z CLAMP
LK5279A**
Scale 1:3
Length : 32 mm
Finishing : M.F

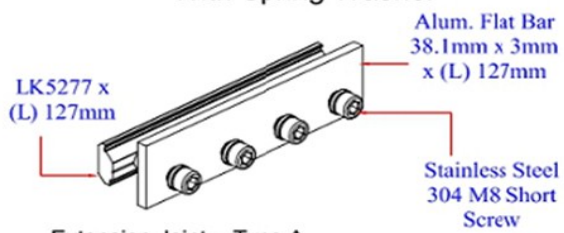

Extension Joint - Type A
Price : RM 7.50 /set

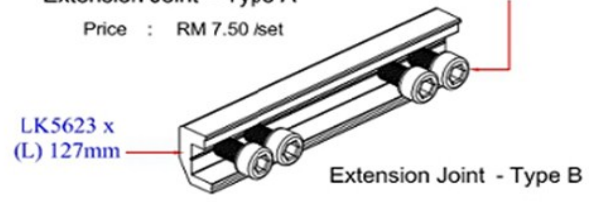

Extension Joint - Type B